

If the magnetic channel is too loud

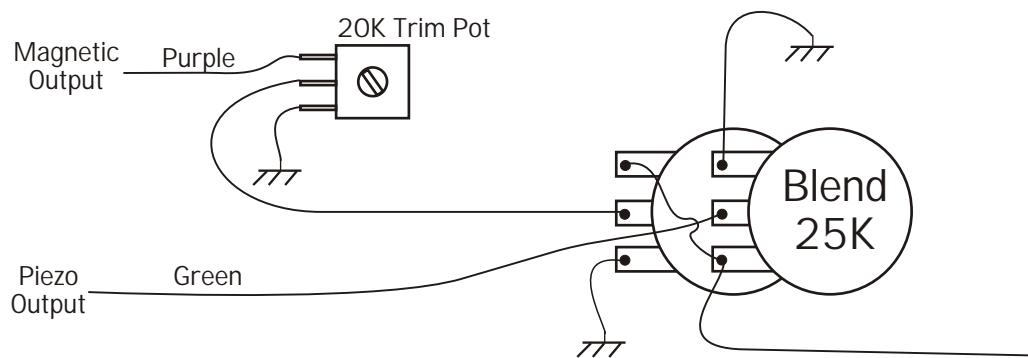

If the piezo channel is too loud

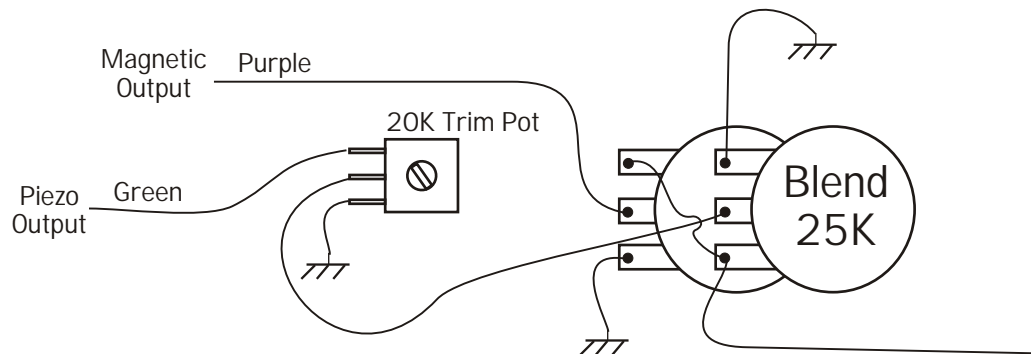

2 Magnetic Pickups & 1 Piezo Pickup with MPB2 & NTMB

